



香港城市大學  
City University of Hong Kong

專業 創新 胸懷全球  
Professional · Creative  
For The World

# CityU Scholars

## Influencing Mechanism of Signal Design Elements in Complex Human–Machine System Evidence from Eye Movement Data

Man, Siu Shing; Hu, Wenbo; Zhou, Hanxing; Zhang, Tingru; Chan, Alan Hoi Shou

**Published in:**  
Informatics

**Published:** 01/12/2024

**Document Version:**

Final Published version, also known as Publisher's PDF, Publisher's Final version or Version of Record

**License:**  
CC BY

**Publication record in CityU Scholars:**  
[Go to record](#)

**Published version (DOI):**  
[10.3390/informatics11040088](https://doi.org/10.3390/informatics11040088)

**Publication details:**

Man, S. S., Hu, W., Zhou, H., Zhang, T., & Chan, A. H. S. (2024). Influencing Mechanism of Signal Design Elements in Complex Human–Machine System: Evidence from Eye Movement Data. *Informatics*, 11(4), Article 88. <https://doi.org/10.3390/informatics11040088>

**Citing this paper**

Please note that where the full-text provided on CityU Scholars is the Post-print version (also known as Accepted Author Manuscript, Peer-reviewed or Author Final version), it may differ from the Final Published version. When citing, ensure that you check and use the publisher's definitive version for pagination and other details.

**General rights**

Copyright for the publications made accessible via the CityU Scholars portal is retained by the author(s) and/or other copyright owners and it is a condition of accessing these publications that users recognise and abide by the legal requirements associated with these rights. Users may not further distribute the material or use it for any profit-making activity or commercial gain.

**Publisher permission**





Permission for previously published items are in accordance with publisher's copyright policies sourced from the SHERPA RoMEO database. Links to full text versions (either Published or Post-print) are only available if corresponding publishers allow open access.

**Take down policy**

Contact [lbscholars@cityu.edu.hk](mailto:lbscholars@cityu.edu.hk) if you believe that this document breaches copyright and provide us with details. We will remove access to the work immediately and investigate your claim.

## Article

# Influencing Mechanism of Signal Design Elements in Complex Human–Machine System: Evidence from Eye Movement Data

Siu Shing Man <sup>1</sup> , Wenbo Hu <sup>2,3</sup> , Hanxing Zhou <sup>4</sup>, Tingru Zhang <sup>4,\*</sup>  and Alan Hoi Shou Chan <sup>2,3</sup> <sup>1</sup> School of Design, South China University of Technology, Guangzhou 510006, China; ssman6@scut.edu.cn<sup>2</sup> Department of Systems Engineering, City University of Hong Kong, Hong Kong, China; wenbo\_hu2018@163.com (W.H.); alan.chan@cityu.edu.hk (A.H.S.C.)<sup>3</sup> Shenzhen Research Institute, City University of Hong Kong, Shenzhen 518060, China<sup>4</sup> Institute of Human Factors and Ergonomics, College of Mechatronics and Control Engineering, Shenzhen University, Shenzhen 518060, China; 2060291005@email.szu.edu.cn

\* Correspondence: zhangtr@szu.edu.cn

**Abstract:** In today's rapidly evolving technological landscape, human–machine interaction has become an issue that should be systematically explored. This research aimed to examine the impact of different pre-cue modes (visual, auditory, and tactile), stimulus modes (visual, auditory, and tactile), compatible mapping modes (both compatible (BC), transverse compatible (TC), longitudinal compatible (LC), and both incompatible (BI)), and stimulus onset asynchrony (200 ms/600 ms) on the performance of participants in complex human–machine systems. Eye movement data and a dual-task paradigm involving stimulus–response and manual tracking were utilized for this study. The findings reveal that visual pre-cues can captivate participants' attention towards peripheral regions, a phenomenon not observed when visual stimuli are presented in isolation. Furthermore, when confronted with visual stimuli, participants predominantly prioritize continuous manual tracking tasks, utilizing focal vision, while concurrently executing stimulus–response compatibility tasks with peripheral vision. Furthermore, the average pupil diameter tends to diminish with the use of visual pre-cues or visual stimuli but expands during auditory or tactile stimuli or pre-cue modes. These findings contribute to the existing literature on the theoretical design of complex human–machine interfaces and offer practical implications for the design of human–machine system interfaces. Moreover, this paper underscores the significance of considering the optimal combination of stimulus modes, pre-cue modes, and stimulus onset asynchrony, tailored to the characteristics of the human–machine interaction task.

**Keywords:** eye movement data; pre-cue modes; stimulus modes; compatible mapping modes; stimulus onset asynchrony; complex human–machine system



**Citation:** Man, S.S.; Hu, W.; Zhou, H.; Zhang, T.; Chan, A.H.S. Influencing Mechanism of Signal Design Elements in Complex Human–Machine System: Evidence from Eye Movement Data. *Informatics* **2024**, *11*, 88. <https://doi.org/10.3390/informatics11040088>

Academic Editor: Luc Bidaut

Received: 20 September 2024

Revised: 11 November 2024

Accepted: 18 November 2024

Published: 21 November 2024



**Copyright:** © 2024 by the authors. Licensee MDPI, Basel, Switzerland. This article is an open access article distributed under the terms and conditions of the Creative Commons Attribution (CC BY) license (<https://creativecommons.org/licenses/by/4.0/>).

## 1. Introduction

Amidst the swift evolution of interactive devices and the development of Industry 4.0 technologies, human–machine systems have emerged as indispensable instruments for contemporary society in different domains, including transportation [1,2], power [3], and healthcare [4,5]. Human–machine interaction often plays a significant role in improving the process of production [6] and enhancing the efficiency of people's work and quality of life [7]. Nevertheless, the realization of automation in human–machine systems has a long way to go, which requires manual oversight during operational tasks [8,9]. Therefore, the interaction between participants and human–machine systems have been common in practice. Stimulus–response compatibility tasks are a fundamental form of human–machine interaction tasks [10,11]. Specifically, all human–machine interaction tasks can be regarded as basic stimulus–response compatibility tasks requiring the participants to respond quickly through mapping methods. For instance, the timely correction of lane deviation while driving a vehicle relies heavily on the participant's response, and the implementation

of these stimulus–response compatibility tasks hinges on the design of human–machine interfaces. The human–machine interface design can improve multiple aspects of manufacturing or production, such as enhancing the efficiency of human–machine interaction [12], reducing operational load [6], increasing operational accuracy [6], and mitigating safety mishaps [13,14].

As an essential platform for information exchange in human–machine systems, the rationality and effectiveness of human–machine interfaces directly affect the performance of human–machine interaction tasks and the reaction time of participants in emergencies [15,16]. Therefore, improving the design of human–machine interfaces has garnered significant attention from scholars [17]. To be specific, one crucial aspect of human–machine interface design involves stimulus signals, which are sensory information outputs provided to participants in specific scenarios, which can help them to capture users’ attention and avoid potential dangers [18]. From this perspective, human–machine systems are reliant on stimulus signals [18], such as collision warnings in car driving and sudden stop signals in mechanical processing. Therefore, the stimulus signals should be paid special attention in terms of the design of human–machine interfaces.

In the design of stimulus signals, the stimulus modes, location, and intensity should all be carefully considered. Existing scholars have paid extensive attention to stimulus modes and stimulus–response compatibility (SSRC) [19]. Stimulus modes refer to the type of sensory information used in human–machine interaction (i.e., visual, auditory, and tactile modes) [10,20]. SSRC refers to the correspondence between the stimulus’ location and the response [21]. Previous studies have confirmed that the stimulus modes and the level of SSRC can both affect participants’ performance [10,11,22–24]. However, the existing research was conducted across diverse contexts and settings, which has led to inconsistencies and conflicting results, highlighting the need for a more unified and comprehensive understanding of these factors in stimulus signal design.

The evolution of human–machine systems has led to a significant shift in human–machine interaction tasks. These tasks have moved beyond the basic stimulus–response paradigm and have evolved into complex systems, often involving dual-task scenarios. In this context, dual tasks refer to scenarios where a participant is required to concurrently perform manual tracking tasks and stimulus–response compatibility tasks [10,24,25]. In dual-task situations, participants need to pay attention to different human–machine interfaces and response controls, which require sensory and physical resources. Furthermore, designers have attempted to introduce pre-cues before the stimulus appears to reduce the participants’ reaction time. Pre-cues can be regarded as the prompt signals that appear before an emergency occurs, which can inform the participants of the danger, guiding them to respond to dangers accordingly [26,27]. These phenomena occur widely in our lives, including traffic light systems, manufacturing lines, and schools. For instance, when students are asked to take a listening test, the broadcast may include pre-cues to attract their attention and help them focus on the task. Moreover, pre-cues have demonstrated many benefits. For example, they can assist participants in preparing for the upcoming stimulus and concentrating on the coming tasks [28]. However, pre-cues also have negative impacts. For instance, when the pre-cues are misleading or inaccurate, they can lead participants to focus on incorrect information, resulting in potential errors in their tasks [29]. In addition, the time interval between the pre-cue and the stimulus, known as stimulus onset asynchrony (SOA), also needs to be considered. A long SOA allows participants sufficient reaction time for the stimulus–response compatibility task, but an excessively long SOA can cause the preparatory effect triggered by the pre-cue to disappear and make the participants neglect other tasks [30,31]. Therefore, further exploration is needed to determine the optimal SOA that allows the pre-cue to exert its maximum utility.

Moreover, physiological information is a representation of participants’ attention and mental states, which can provide insights into the changes in participants’ performance from the perceptual and cognitive dimensions [32,33]. Some scholars have utilized eye movement signals to investigate focal vision and visual changes during tasks [34,35].

However, the existing literature failed to consider multiple factors (i.e., stimulus modes, pre-cue modes, compatible mapping modes, and SOA) and their combined effects on participants' performance. Therefore, this paper introduced eye movement data to reveal the mechanisms by which factors affect participants' performance.

Based on these aspects, this study aimed to explore the effects of various factors (i.e., pre-cue modes, stimulus modes, compatible mapping modes, and SOA) on participants' physiological responses in dual-task scenarios within human-machine systems. Herein, this experiment integrated manual tracking and stimulus-response compatibility tasks, providing insight into the cognitive demands of complex scenarios. The experiment introduced eye movements as a signal to examine participants' responses in dual-task scenarios within complex human-machine system environments. This study lays the theoretical foundation for signal presentation techniques during emergencies, serving as a reference for optimizing the efficiency and safety of human-machine systems. From a practical standpoint, this paper offers valuable insights for human-machine system engineers and ergonomists in developing advanced human-machine systems. Specifically, our findings can contribute to the development of user-centric, high-performing interfaces that ultimately enhance participants' performance in complex and dynamic environments. However, our findings apply to human-machine systems that include pre-cue modes, stimulus modes, compatible mapping modes, and SOA. These findings may not be directly applicable to other types of human-machine systems.

## 2. Materials and Methods

### 2.1. Participants

To ensure the reliability of the results, it is essential to recruit enough qualified participants. The number of participants in this research was estimated using G\*Power version 3.1.9.7 [36]. With an effect size of 0.25 and a desired power of 0.95, it was determined that a minimum of 44 participants would be needed. A total of 72 individuals were recruited from the student population in our study, and the sample included 44 males and 28 females from 18 to 29 years old. All participants in this study were right-handed individuals with normal or corrected-to-normal vision, normal hearing, and no color blindness or color weakness.

### 2.2. Experiment Tasks and Materials

The experiment employed a dual-task paradigm consisting of a manual tracking task (Task 1) and a stimulus-response compatibility task (Task 2). In Task 1, participants were presented with a white square frame that contained a randomly moving circular target and a crosshair control cursor. Both the target and cursor were confined to a designated square frame within the visual scene, as illustrated in Figure 1. The objective of this task was to manipulate a joystick to maneuver the crosshair cursor, aiming to track and align it as precisely as possible with the moving target. The joystick used for controlling the manual tracking task is depicted in Figure 2a, enabling participants to navigate the cursor with accuracy.

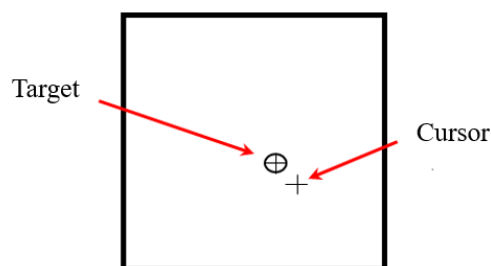
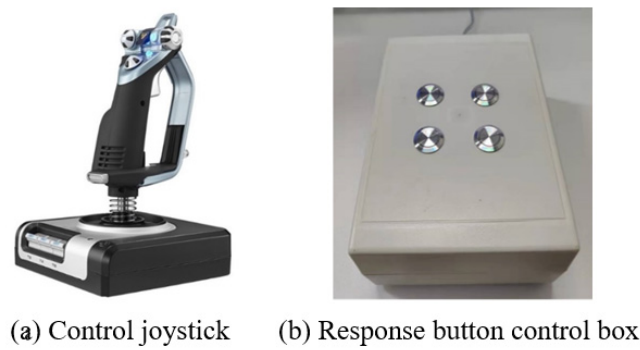
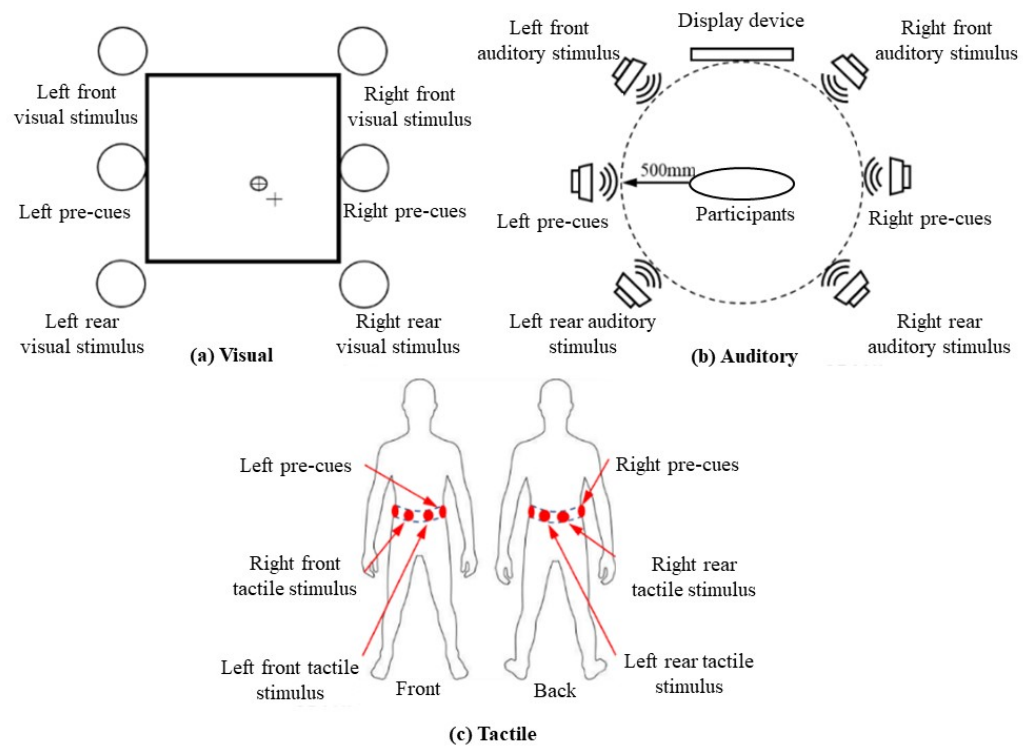

Figure 1. Manual tracking scene.



**Figure 2.** Tracking facilities in the experiment.

In the stimulus–response compatibility task (Task 2), the stimulus signals were delivered in three distinct modes: visual, auditory, and tactile. For the visual stimuli, circular markers were placed outside the four corners of the square frame on the same interface as the manual tracking task (Figure 3a). Upon activation, a specific circle would be filled with a color, indicating the location of the visual stimulus. For the auditory stimuli, speakers were positioned in front left, front right, rear left, and rear right directions relative to the participant (Figure 3b). When triggered, these speakers emitted a 790 Hz tone with a sound level of 90 decibels, resembling a distinct “beep” sound. The tactile stimuli were administered through a length-adjustable vibrator attached securely to the participant’s waist (Figure 3c). Upon activation, the vibrator produced vibrations with a frequency of 190 Hz and a peak displacement of 0.015 mm, providing a distinct tactile sensation. Following the activation of any stimulus, participants were instructed to swiftly press the corresponding button on the control box, adhering to a predefined stimulus–response mapping. If the response was not initiated promptly, the stimulus would automatically terminate after 1000 ms.

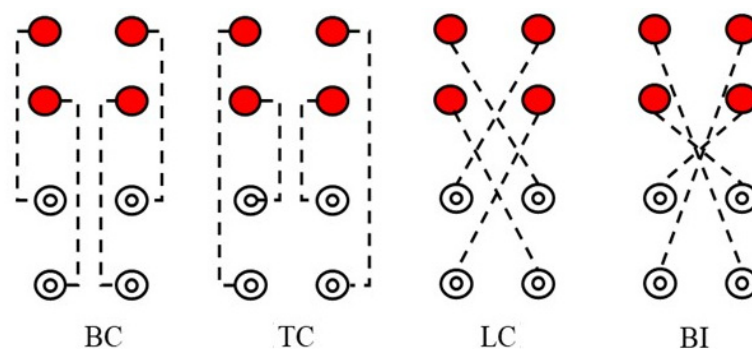

**Figure 3.** Stimulus location in different modes.

In the stimulus–response compatibility task, the stimulus involves eliciting a response from the operator through the utilization of physiological cues. Conversely, the response represents the operator’s action of pressing a designated button upon receiving the physiological stimulus. Within this framework, a stimulus signal is presented in one of four distinct orientations: upper left, upper right, lower left, or lower right. Subsequently, the operator must respond precisely, aligning their action with the directional cue by pressing the corresponding button located on the control box. The layout of the buttons for this stimulus–response compatibility task is depicted in Figure 2b.

Pre-cues serve as antecedent signals preceding the emergence of a stimulus without directly eliciting a response from the operator. These cues provide a hint about the imminent location of subsequent stimuli, indicating whether they will appear on the left or right. In the current study, three distinct modes were employed to convey pre-cues: visual, auditory, and tactile. For visual pre-cues, circles were displayed on either side of a central box (Figure 3a). The circle corresponding to the upcoming stimulus location was instantly filled with a color. Auditory pre-cues were delivered through speakers positioned on both sides of the central box, emitting sounds with parameters identical to those of the auditory stimuli (Figure 3b). Tactile pre-cues were provided by vibrators placed on the left and right, with parameters consistent with the tactile stimuli (Figure 3c). The duration of pre-cues across all modes was standardized at 200 ms.

In this study, the SSRC included four mapping conditions: both compatible (BC), transverse compatible (TC), longitudinal compatible (LC), and both incompatible (BI), as illustrated in Figure 4. In the BC mapping, the spatial location of the stimulus signal aligns with the vertical and horizontal orientations of the response buttons. For instance, if the stimulus signal appears at the “right-front” position, the operator is required to press the button located at the corresponding “right-front” position on the control box. Conversely, the BI mapping represents a complete reversal of the BC mapping, necessitating the pressing of buttons that are opposed to the horizontal and vertical directions of the stimulus signal. The TC mapping demonstrates a stimulus–response relationship where the horizontal alignment is maintained but the vertical correspondence is disrupted. Finally, the LC mapping exhibits a stimulus–response mapping where the vertical alignment is preserved while the horizontal alignment is disrupted.



**Figure 4.** Stimulus–response mapping relationship.

### 2.3. Independent Variables

The experiment design consisted of four independent variables, namely stimulus modes (within-group variable), pre-cue modes (within-group variable), compatible mapping modes (between-group variable), and SOA (within-group variable). The levels of each independent variable were as follows. The stimulus modes were segmented into three levels: visual, auditory, and tactile. The pre-cue modes also encompassed three levels: visual, auditory, and tactile. The compatible mapping modes comprised four levels: BC, LC, TC, and BI. Finally, the SOA was varied across two levels: 200 ms and 600 ms. The comprehensive list of experimental independent variable levels is outlined in Table 1.

**Table 1.** Independent variables in this experiment and their levels.

Groups	Independent Variables	Levels			
Within-group variable	Stimulus modes	Visual	Auditory	Tactile	
	Pre-cue modes	Visual	Auditory	Tactile	
	SOA	200 ms	600 ms		
Between-group variable	Compatible mapping modes	BC	TC	LC	BI

#### 2.4. Dependent Variables

The experiment collected eye movement data from the participants, which has been widely employed in human–machine interaction studies [37,38]. In this paper, the eye movement data can be classified into two types: area of interest (AOI) eye movement data and basic eye movement metrics. The AOI eye movement data included the proportion of total fixation duration on AOIs and the proportion of fixation count on AOIs. The basic eye movement metrics included average pupil diameter and average blink rate. There are two reasons for choosing these variables to reflect eye movement. First, these indicators are commonly used and easy to measure without causing any physical harm to the participants. Second, these variables were selected to capture various aspects of eye movement behavior and offer insights into cognitive processes, attention allocation, and physiological arousal levels during the experiment. Specifically, the fixation duration ratio refers to the percentage of time that the participant’s fixation remains in the AOI compared to the fixation duration in all AOIs under the same experimental conditions [39]. The average pupil diameter serves as an indicator of arousal level or cognitive load [40]. A larger pupil diameter generally suggests heightened arousal or increased cognitive load. Conversely, the blink rate, measured as the number of blinks per unit of time, is a metric for evaluating ocular health and lubrication maintenance mechanisms [41].

#### 2.5. Experiment Procedures

The 72 participants were randomly distributed across four groups, each tasked with completing 18 experimental conditions. These conditions were defined by a combination of three pre-cue modes, two SOAs, and three stimulus modes, all executed under a specified stimulus–response mapping method. During the experiment, participants were required to provide six accurate responses for each button position within each experimental condition before proceeding to the next one. As a result, to complete the experiment, each participant was required to accumulate a cumulative total of 432 correct responses, achieved through 18 conditions, 4 button positions, and 6 repetitions per condition.

At the beginning of the experiment, the circular random target overlapped with the crosshair cursor, positioned at the center of a square visual scene. Participants were instructed to place their right hand on the control joystick and their left index and middle fingers on the buttons of the control box. Pressing any button on the control box initiated the manual tracking task. The first pre-cue signal randomly appeared within 1 to 4 s after the start of the manual tracking task, followed by the stimulus signal after the SOA interval. Upon the appearance of the stimulus, participants were instructed to promptly press the corresponding button, adhering to the prescribed mapping method, thereby completing a single stimulus–response compatibility task. Subsequently, a randomized interval ranging from 1 to 4 s elapsed, preceding the presentation of the subsequent pre-cue. Figure 5 illustrates the sequence of events in the stimulus–response compatibility task, encompassing both auditory pre-cue and visual stimulus conditions. If a participant failed to depress a button within 1000 ms of the emergence of the stimulus, it was recorded as a missed response. Similarly, if a button was pressed incorrectly, inconsistent with the mapping method, it was categorized as an incorrect response.

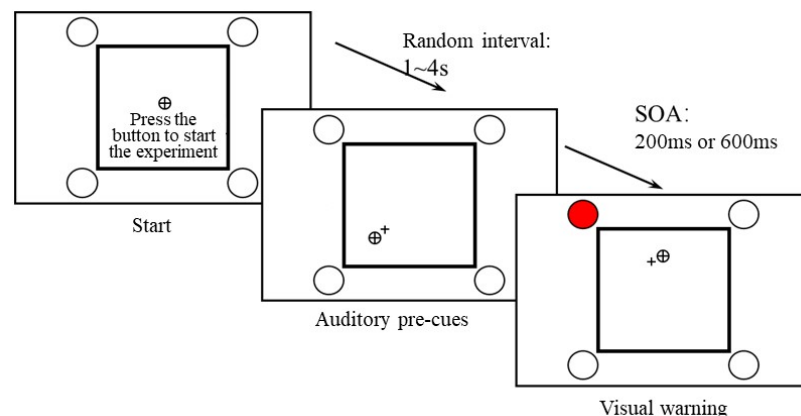

**Figure 5.** Auditory pre-cues and visual stimulus–response compatibility tasks.

Before the experiment, this study took some measures to ensure all participants became accustomed to the experiment procedures and experiment facilities. Specifically, experimenters provided a detailed introduction to the experiment content and procedures for the participants, emphasizing the requirements of the experiment. After fully understanding the experiment content, the participants wore, calibrated, and sampled the facilities. Before the experiment, participants must complete sufficient tests. In these tests, each position only required the participant to respond correctly once to exit the test under the current conditions. To ensure that participants can accurately distinguish stimuli from different positions under any testing conditions, only those who completed one round of tests without any errors could proceed to the formal experiments. To ensure that participants fully master the use of the control joystick before the formal experiments, the experimenter may decide to add practice tests based on the participants' performance in manual tracking tasks. Throughout the experiment, participants did not receive any feedback for correct, incorrect, or missed responses. Additionally, the stimulus signal would abruptly cease upon the pressing of a button. Participants were instructed to sustain their engagement in a manual tracking task, executing it consistently with their right hand. However, when presented with a stimulus–response compatibility task, they were required to shift their focus and utilize their left hand to execute the necessary responses. After completing the task, they were instructed to redirect their attention to the ongoing manual tracking task, readying themselves for the stimulus–response capability task. These two tasks are equally prioritized in this study.

### 2.6. Brief Introduction to the Accuracy of the Tasks

This study documented the performance of participants across various experimental conditions. Regarding stimulus modes, visual stimuli yielded the highest accuracy at 97.7%, whereas auditory stimuli resulted in the lowest, at 87.6%. In terms of pre-cue modes, visual pre-cues again showed the best performance, achieving 91.6% accuracy, with tactile pre-cues demonstrating the least, at 84.4%. Concerning compatibility mapping, the LC method was most effective, reaching 92.0% accuracy, while the BI method was the least accurate, at 89.4%. The analysis of SOA revealed that a 600 ms interval led to a higher accuracy of 92.7% compared to an 89.8% accuracy for a 200 ms interval. Under dual-task conditions, the accuracy ranged from 84.6% to 98.4%. Consequently, visual stimuli or pre-cues were found to be the most accurate in both stimulus and pre-cue modes, respectively. Additionally, a longer SOA generally contributed to improved task performance accuracy among participants.

## 3. Results

### 3.1. Analysis of the Proportion of Total Fixation Duration in the AOI

This study examined eye movements within AOIs. AOIs refer to the selective analysis of specific regions within the visual field, achieved by tracking eye movement signals



and subsequently quantifying the level of interest in those regions through the capture of eye movement behaviors, as depicted in Figure 6. Within this framework, the AOI was segmented into three principal components: a tracking AOI, associated with manual tracking tasks; a left AOI, corresponding to left-sided visual pre-cues and stimuli; and a right AOI, linked to right-sided visual cues and stimuli. By obtaining the distribution of the fixation points across these various AOIs, this paper can gain insights into participants' attention patterns and identify focal points through the hotspot map. Consequently, this study enriches our understanding of how participants' attention fluctuates in dual-task scenarios and attempts to provide insights into attention allocation in human-machine systems.

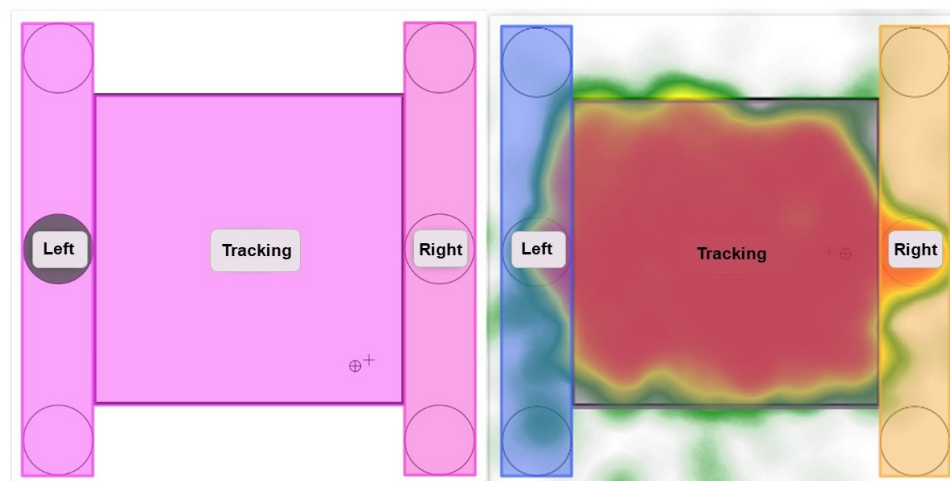

**Figure 6.** Eye movement AOI classification and hotspot map.

The data showed that the main effects of the pre-cue modes on the fixation duration ratios of the tracking AOI ( $F_{(2, 213)} = 15.92, p < 0.001$ ), the left AOI ( $F_{(2, 213)} = 17.78, p < 0.001$ ), and the right AOI ( $F_{(2, 213)} = 17.79, p < 0.001$ ) are all significant. The main effects of the stimulus modes, compatible mapping method, and SOA on the fixation duration ratios of the three AOIs are not significant. Therefore, under visual pre-cues, the fixation duration ratios of both the left and right AOIs are higher than those of auditory and tactile pre-cues. Moreover, based on the findings of the post hoc analysis, the proportion of the fixation duration regarding the tracking AOI was significantly lower under visual pre-cues compared to auditory and tactile pre-cues. Under visual pre-cues, the proportions of the fixation durations on the left AOI and right AOI were higher than under auditory and tactile pre-cues.

The interaction effects of the pre-cue modes and SOA yield notable impacts on the fixation duration ratios for both the tracking AOI ( $F_{(2, 426)} = 3.33, p = 0.039$ ) and the right AOI ( $F_{(2, 426)} = 3.88, p = 0.023$ ). Conversely, no significant interactions are observed for the other factors under investigation. Under different pre-cue modes, the fixation duration ratio of the tracking AOI is generally higher with a 600 ms SOA, peaking with tactile pre-cues and reaching its lowest point with visual pre-cues and a 200 ms SOA. Notably, auditory pre-cues exhibit little variation in the fixation duration ratio within the tracking AOI regardless of the SOA (Figure 7). Meanwhile, according to the interaction analysis of the pre-cue modes and SOA on the fixation duration ratio of the right AOI, SOA has the greatest impact on the proportion of the fixation duration under visual pre-cues. The proportion of the right AOI fixation duration was highest under a 600 ms SOA combination of visual pre-cues, while the proportion was the lowest under a 600 ms SOA combination of tactile pre-cues.

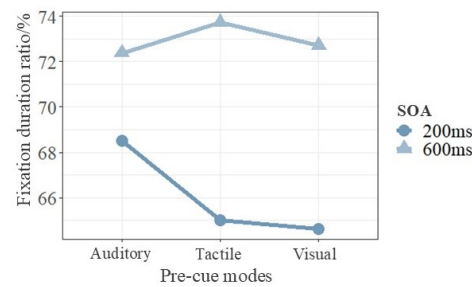

Figure 7. Interaction effects of pre-cue modes and SOA on the fixation duration ratio.

### 3.2. Analysis of Average Pupil Diameter

#### 3.2.1. One-Way Analysis of the Main Effects of Average Pupil Diameter

The results of the one-way analysis of variance for the main effects of average pupil diameter are shown in Table 2. Significant main effects were found for the stimulus modes ( $F_{(2, 213)} = 15.720, p < 0.001$ ) and pre-cue modes ( $F_{(2, 213)} = 17.820, p < 0.001$ ), while no significant differences were observed for the main effects of the other factors. This finding suggests that the stimulus modes and pre-cue modes can significantly affect the average pupil diameter of the participants.

Table 2. One-way analysis of the main effects of average pupil diameter.

Type	Independent Variables	Df	Sum Sq	Mean Sq	F	p
One-way analysis	Stimulus modes	2	0.184	0.09	15.720	<0.001
	Pre-cue modes	2	0.085	0.04	17.820	<0.001
	Compatible mapping modes	3	0.231	0.08	0.556	0.646
	SOA	1	0.000	0.00	0.001	0.981

The results of the post hoc tests for one-way analysis are shown in Figure 8. The average pupil diameter under visual stimuli was significantly smaller than that under auditory and tactile stimuli (Figure 8a). There were significant differences in the average pupil diameter between each pair of pre-cue modes. Specifically, the visual pre-cue modes had the most minor average pupil diameter, while the auditory pre-cue modes had the largest average pupil diameter (Figure 8b). The difference in average pupil diameter can be attributed to attention allocation and the cognitive process [42,43], which can also enrich the Multiple Resource Theory.

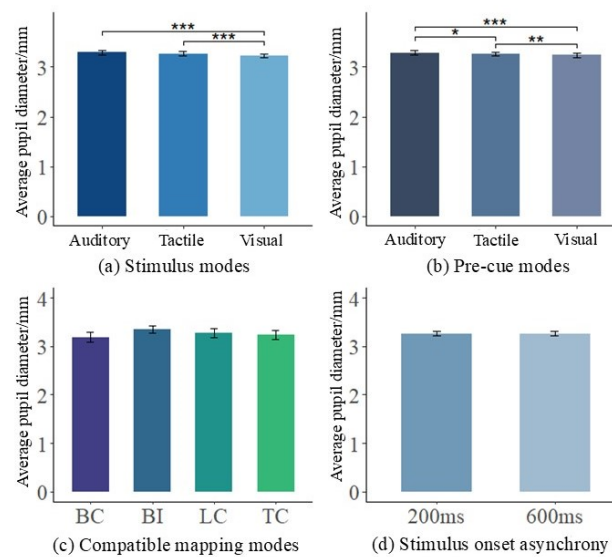

Figure 8. Post hoc tests of average pupil diameter. Note: \*\*\*  $p < 0.01$ ; \*\*  $p < 0.05$ ; \*  $p < 0.1$  (two-tailed test).

### 3.2.2. Analysis of the Interaction Effects of Average Pupil Diameter

The results of the interaction effects of average pupil diameter for the two-way analysis are shown in Table 3, which shows that none of the interaction effects for the interaction terms were significant.

**Table 3.** Interaction effects of average pupil diameter.

Type	Independent Variables	Df	Sum Sq	Mean Sq	F	p
Interaction effects	Stimulus modes × Compatible mapping modes	6	0.039	0.007	1.117	0.356
	Stimulus modes × Pre-cue modes	4	0.015	0.004	1.281	0.278
	Stimulus modes × SOA	2	0.003	0.002	0.238	0.788
	Pre-cue modes × SOA	2	0.002	0.001	0.419	0.659

### 3.3. Analysis of Average Blink Rate

#### 3.3.1. One-Way Analysis of the Main Effects of Average Blink Rate

The results of the one-way analysis of variance for the main effects of average blink rate are shown in Table 4. The main effects of SOA ( $F_{(1, 142)} = 6.058, p = 0.016$ ) were found to be significant, and no significant main effects were observed for the other factors. The post hoc test results are shown in Figure 9. It can be observed that the average blink rate under the 200 ms SOA condition was significantly higher than that under the 600 ms SOA condition (Figure 9c). This indicates that, the shorter the SOA, the higher the average blink rate.

**Table 4.** One-way analysis of the main effects of average blink rate.

Type	Independent Variables	Df	Sum Sq	Mean Sq	F	p
One-way analysis	Stimulus modes	2	0.030	0.015	1.117	0.330
	Pre-cue modes	2	0.000	0.000	0.023	0.977
	Compatible mapping modes	3	0.755	0.252	2.139	0.103
	SOA	1	0.120	0.120	6.058	0.016

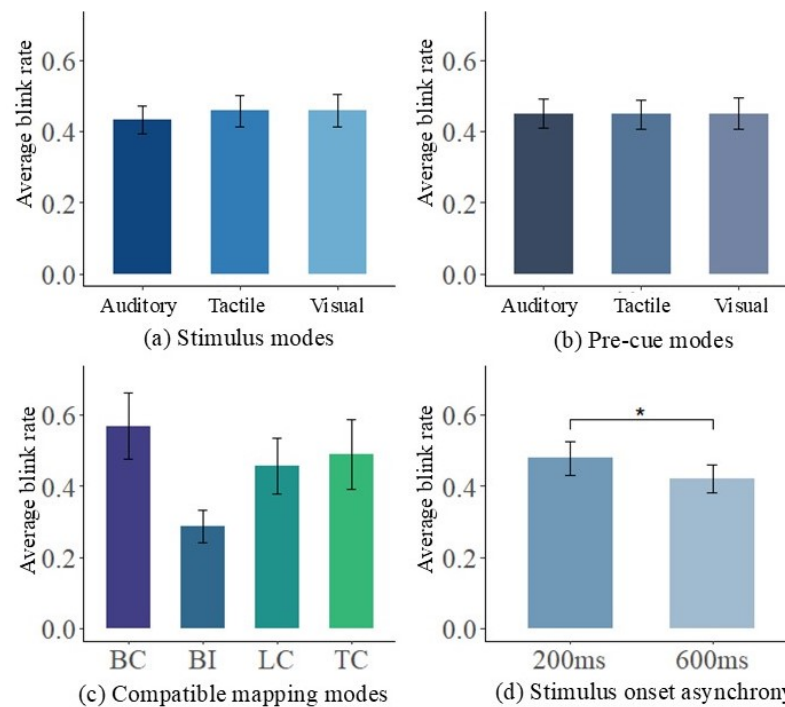

**Figure 9.** Post hoc tests of average blink rate. Note: \*  $p < 0.1$  (two-tailed test).

### 3.3.2. Analysis of the Interaction Effects of Average Blink Rate

The results of the interaction effects of the average blink rate for the two-way analysis are shown in Table 5, which shows that none of the interaction effects for the two factors were found to be significant.

**Table 5.** Interaction effects of average blink rate.

Type	Independent Variables	Df	Sum Sq	Mean Sq	F	p
Interaction effects	Stimulus modes × Compatible mapping modes	6	0.038	0.006	0.464	0.834
	Stimulus modes × Pre-cue modes	4	0.075	0.019	1.923	0.107
	Stimulus modes × SOA	2	0.004	0.002	0.143	0.867
	Pre-cue modes × SOA	2	0.003	0.002	0.270	0.763

## 4. Discussion

### 4.1. In-Depth Analysis of the Experiments and Results

This paper analyzed eye movement data in human–machine interfaces to obtain an in-depth understanding of the mechanisms of complex human–machine systems. First, a sufficient number of participants were recruited to ensure statistical reliability. Second, this study reported the accuracy of the participants in different tasks to provide more detailed information regarding these tasks. Then, eye movement metrics such as average pupil diameter and average blink rate were extracted, and clear definitions of these metrics were provided. Last, a one-way ANOVA was performed to investigate the main effects and interaction effects on the eye movement data to identify the factors that impact these eye movement metrics.

The results of the task accuracy analysis indicate that visual stimuli, whether in the stimulus or pre-cue modes, lead to the highest performance accuracy among the participants. Conversely, the lowest accuracy varied between the stimulus and pre-cue modes, with auditory pre-cues and tactile stimuli often resulting in a higher incidence of operational errors during the experiments. Therefore, it is advisable to minimize the use of auditory pre-cues and tactile stimuli in human–machine systems. Additionally, providing participants with more reaction time enhances the accuracy of participants, and the LC mapping method also contributes to higher accuracy. Thus, the appropriate design of human–machine system interfaces can facilitate task accuracy and reduce operational errors.

Moreover, distinct characteristics can be observed in the eye movement behavior across various scenarios. Notably, the stimulus modes and pre-cue modes had a significant impact on the average pupil diameter. Specifically, visual stimuli elicited the smallest average pupil diameter compared to the other stimulus modes. This outcome can be attributed to the typically high intensity associated with visual stimuli, which leads to pupil constriction as a response to regulating the amount of light entering the eyes [44,45]. Therefore, the average pupil diameter is smaller under visual stimuli. Regarding the different pre-cue modes, visual pre-cues result in the most minor average pupil diameter, while auditory pre-cues result in the largest average pupil diameter. Visual pre-cues, often laden with crucial task information, guide individuals' attention toward visual inputs. In this context, the pupils constrict to enhance the perception and processing of visual details [46]. In parallel, participants tend to adopt a more expansive scope when attending to auditory information, enabling them to perceive and interpret their external environment. As a result, their attention is less concentrated on visual stimuli, leading to pupil dilation. This broadening of attention enables the integration of auditory cues with other sensory inputs, yet it also redirects the focus away from visual cues.

In addition, some interesting findings emerged from this study. It was observed that the stimulus modes and pre-cue modes significantly impact the average pupil diameter. However, the interaction effects between these two variables were not statistically significant. Nevertheless, there were significant differences in the average pupil diameter across various stimulus and pre-cue modes, suggesting that different combinations of these modes can produce diverse outcomes. Therefore, a detailed analysis of the specific pairings between the stimulus and pre-cue modes is essential to obtain a comprehensive understanding of their effects.

Regarding the average blink rate, significant differences in participants' average blink rates can be observed under different SOA conditions. Specifically, the average blink rate is significantly higher under the condition of 200 ms SOA compared to the condition of 600 ms SOA. The increase in blink rate may be attributed to three reasons. First, the state of attention and cognitive load plays a pivotal role [47,48]. When the SOA is set at 200 ms, the shorter interval between the stimulus and task demands a high level of cognitive processing, requiring increased attention from the participants. This surge in cognitive load subsequently triggers an increased blink rate. Conversely, at a 600 ms SOA, the elongated interval permits a lessened cognitive load, reflected in a relatively lower blink rate. Second, memory decay, which varies across time intervals, can influence cognitive states [49,50]. Specifically, at a 200 ms SOA, participants can retain more information compared to a 600 ms SOA, thereby experiencing a lower blink rate. Third, the blink rate augmentation may be linked to eye fatigue [41]. In the context of a 200 ms SOA, the shortened interval between the stimulus and task results in a higher frequency of stimuli, which can induce eye fatigue and dryness, ultimately prompting the blink response. However, at a 600 ms SOA, the longer interval affords the eyes more time to adapt to the stimuli, thereby reducing eye fatigue and dryness and consequently leading to a diminished blink rate.

Furthermore, the impact of compatible mapping modes on the participants' performance was found to be non-significant in both the analysis of average pupil diameter and the analysis of average blink rate. Therefore, when designing future experiments, especially those involving stimulus–response compatibility tasks, less attention can be paid to the compatible and incompatible modes. However, this finding can only be observed using the eye movement data, and more evidence is required to further support this finding. In addition, certain metrics displayed significant effects in the one-way analysis of variance. However, when examining the interaction effects in the two-way analysis of variance, these effects were not statistically significant. This finding implies that it can be more efficient to modify a single factor in some contexts when designing human–machine interfaces as considering the interaction effects between factors may have limited significance.

#### 4.2. Limitations and Future Directions

There are some limitations that must be addressed in this research. First, only 72 participants were included in our study, although meeting the minimum requirements, may lack adequate statistical power, thereby compromising the robustness of the conclusions. To bolster the reliability of the findings in future studies, a substantially larger participant pool is imperative.

Second, this study just focused on students aged 18 to 29 years, which constrains the generalizability of the results. A diverse age range of participants should be included in future studies to strengthen the reliability and provide guidance for designing human–machine interfaces tailored to specific user groups.

Third, this study relied solely on eye movement data to assess operator responses in a complex human–machine interface design, which oversimplifies the complexity of human–machine interactions. Future studies could incorporate additional physiological response indicators, such as electroencephalogram data, to offer a holistic understanding of the operator's cognitive and emotional states.

Last, this study was conducted within specific experiments of human–machine systems, which may not serve as a sufficient reference point regarding other contexts. Therefore,

future research could undertake parallel studies in different contexts and compare their findings with this study. These comparisons and insights would enhance the reliability of our results and provide comprehensive insights into the design of human–machine interfaces.

#### 4.3. Practical Implications

Based on the analysis results, this paper provided the following practical recommendations for human–machine interface design:

First, attention should be paid to the strategic use of visual stimuli. Given that the average pupil diameter is smaller during visual stimuli, it becomes imperative to prioritize sufficient brightness and contrast in the design of human–machine interfaces [51], which will enhance the perceptual and processing capabilities of the participants. Additionally, to avoid unnecessary distractions, the use of visual cues should be minimized to ensure that they do not interfere with the task performance.

Second, the design of the pre-cue mode should be optimized. Our results indicate that visual pre-cues induce a reduced average pupil diameter, suggesting a heightened focus on visual input. Therefore, it is vital to provide clear and explicit visual pre-cues when designing human–machine interfaces, considering the goals and requirements of these tasks. While auditory pre-cues may offer less information, they play a significant role in human–computer interaction. Human–machine interface designers should carefully consider the combination of auditory, tactile, and visual cues to ensure that they complement each other rather than compete for participants' attention.

The third recommendation includes enhancing the ergonomics of the human–machine interfaces and setting appropriate SOA conditions based on the task requirements to balance the cognitive load and users' feelings. As such, the spatial arrangement of tasks should be carefully configured to minimize eye movements, simplify operational processes, and improve user efficiency, which are potential avenues to refine the design of human–machine interfaces [52,53]. Moreover, the participants' physiological and performance indicators should be monitored in designing human–machine interfaces.

## 5. Conclusions

This study offers theoretical and practical perspectives by collecting the physiological responses of participants amidst complex dual-task scenarios in human–machine interface design. The findings can be applied to refine the design of human–machine system interfaces, curtailing users' reaction times in emergency scenarios and improving the efficiency of users. This study revealed that visual pre-cues attract participants' attention to the left and right areas, a phenomenon that is absent under visual stimuli alone, suggesting that visual pre-cues can attract the participants. Under visual stimuli, participants primarily engage in continuous manual tracking tasks with focal vision. In contrast, stimulus–response compatibility tasks are performed using peripheral vision, allowing them to maintain focus on manual tracking. Moreover, this study observed that the average pupil diameter decreases under visual pre-cues and visual stimuli but increases under auditory or tactile stimuli and pre-cue modes. Finally, when human–machine systems involve multiple visual tasks, it is crucial to minimize the distance between the tasks, enabling the participants to utilize both focal and peripheral vision for concurrent tasks.

**Author Contributions:** Conceptualization, S.S.M., T.Z. and A.H.S.C.; methodology, W.H., H.Z. and T.Z.; software, W.H. and H.Z.; validation, S.S.M., T.Z. and A.H.S.C.; formal analysis, W.H., H.Z. and T.Z.; investigation, H.Z. and T.Z.; resources, S.S.M., T.Z. and A.H.S.C.; data curation, T.Z.; writing—original draft preparation, S.S.M., W.H., H.Z. and T.Z.; writing—review and editing, S.S.M., W.H., H.Z., T.Z. and A.H.S.C.; visualization, W.H. and H.Z.; supervision, S.S.M., T.Z. and A.H.S.C.; project administration, S.S.M., T.Z. and A.H.S.C.; funding acquisition, S.S.M., T.Z. and A.H.S.C. All authors have read and agreed to the published version of the manuscript.

**Funding:** This work was supported by the National Natural Science Foundation of China (grant number 72071170), and the Guangdong Basic and Applied Basic Research Foundation (grant number 2024A1515030219).

**Institutional Review Board Statement:** This research complied with the American Psychological Association Code of Ethics and was approved by the Institutional Review Board at City University of Hong Kong.

**Informed Consent Statement:** Informed consent for participation was obtained from all subjects involved in the study.

**Data Availability Statement:** The data presented in this study are available on request from the corresponding author.

**Conflicts of Interest:** The authors declare no conflicts of interest.

## References

1. Li, A.; Ma, X.; Guo, J.; Zhang, J.; Wang, J.; Zhao, K.; Li, Y. Driver fatigue detection and human-machine cooperative decision-making for road scenarios. *Multimed. Tools Appl.* **2023**, *83*, 12487–12518. [[CrossRef](#)]
2. Sadiku, M.N.O.; Gupta, N.; Patel, K.K.; Musa, S.M. An Overview of Intelligent Transportation Systems in the Context of Internet of Vehicles. In *Internet of Vehicles and Its Applications in Autonomous Driving*; Springer: Cham, Switzerland, 2021; pp. 3–11.
3. Zou, Y.; Pang, M. Application and Prospect of Human-Machine Interaction in Power System. *J. Phys. Conf. Ser.* **2019**, *1345*, 032094. [[CrossRef](#)]
4. Hou, W.; Ning, Z.; Hu, X.; Guo, L.; Deng, X.; Yang, Y.; Kwok, R.Y.K. On-Chip Hardware Accelerator for Automated Diagnosis Through Human–Machine Interactions in Healthcare Delivery. *IEEE Trans. Autom. Sci. Eng.* **2019**, *16*, 206–217. [[CrossRef](#)]
5. Zou, S.; Tao, L.-Q.; Wang, G.; Zhu, C.; Peng, Z.; Sun, H.; Li, Y.; Wei, Y.; Ren, T.-L. Humidity-Based Human–Machine Interaction System for Healthcare Applications. *ACS Appl. Mater. Interfaces* **2022**, *14*, 12606–12616. [[CrossRef](#)]
6. Kumar, N.; Lee, S.C. Human-machine interface in smart factory: A systematic literature review. *Technol. Forecast. Soc. Change* **2022**, *174*, 121284. [[CrossRef](#)]
7. Salvine, P.; Nicolescu, M.; Ishiguro, H. Benefits of Human–Robot Interaction [TC Spotlight]. *IEEE Robot. Autom. Mag.* **2011**, *18*, 98–99. [[CrossRef](#)]
8. Nardo, M.; Forino, D.; Murino, T. The evolution of man–machine interaction: The role of human in Industry 4.0 paradigm. *Prod. Manuf. Res.* **2020**, *8*, 20–34. [[CrossRef](#)]
9. Lundberg, J.; Johansson, B.J.E. A framework for describing interaction between human operators and autonomous, automated, and manual control systems. *Cogn. Technol. Work* **2021**, *23*, 381–401. [[CrossRef](#)]
10. Tsang, S.N.H.; Chan, A.H.S.; Pan, X.; Man, S.S. Auditory versus visual spatial stimulus-response mappings in tracking and discrete dual task performance: Implications for human-machine interface design. *Ergonomics* **2021**, *64*, 485–501. [[CrossRef](#)]
11. Kang, S.X.; Man, S.S.; Chan, A.H.S. Investigation on the effects of presentation modality for spatial signals on human performance using a dual task paradigm. *Appl. Ergon.* **2023**, *106*, 103898. [[CrossRef](#)]
12. Mahmud, S.; Lin, X.; Kim, J.-H. Interface for Human Machine Interaction for assistant devices: A Review. In Proceedings of the 2020 10th Annual Computing and Communication Workshop and Conference (CCWC), Las Vegas, NV, USA, 6–8 January 2020; IEEE: Piscataway, NJ, USA, 2020; pp. 0768–0773.
13. Zhang, T.; Liu, X.; Zeng, W.; Tao, D.; Li, G.; Qu, X. Input modality matters: A comparison of touch, speech, and gesture based in-vehicle interaction. *Appl. Ergon.* **2023**, *108*, 103958. [[CrossRef](#)] [[PubMed](#)]
14. Liu, J.; Aydin, M.; Akyuz, E.; Arslan, O.; Uflaz, E.; Kurt, R.E.; Turan, O. Prediction of human–machine interface (HMI) operational errors for maritime autonomous surface ships (MASS). *J. Mar. Sci. Technol.* **2022**, *27*, 293–306. [[CrossRef](#)]
15. Pacaux-Lemoine, M.-P.; Trentesaux, D.; Zambrano Rey, G.; Millot, P. Designing intelligent manufacturing systems through Human-Machine Cooperation principles: A human-centered approach. *Comput. Ind. Eng.* **2017**, *111*, 581–595. [[CrossRef](#)]
16. Tan, Z.; Dai, N.; Su, Y.; Zhang, R.; Li, Y.; Wu, D.; Li, S. Human–Machine Interaction in Intelligent and Connected Vehicles: A Review of Status Quo, Issues, and Opportunities. *IEEE Trans. Intell. Transp. Syst.* **2022**, *23*, 13954–13975. [[CrossRef](#)]
17. Inga, J.; Ruess, M.; Robens, J.H.; Nelius, T.; Rothfuß, S.; Kille, S.; Dahlinger, P.; Lindenmann, A.; Thomaschke, R.; Neumann, G.; et al. Human-machine symbiosis: A multivariate perspective for physically coupled human-machine systems. *Int. J. Hum. Comput. Stud.* **2023**, *170*, 102926. [[CrossRef](#)]
18. Peterka, R.J.; Murchison, C.F.; Parrington, L.; Fino, P.C.; King, L.A. Implementation of a Central Sensorimotor Integration Test for Characterization of Human Balance Control During Stance. *Front. Neurol.* **2018**, *9*, 1045. [[CrossRef](#)] [[PubMed](#)]
19. Chan, A.H.S.; Man, S.S.; Zhang, T.; Chan, W.; Alabdulkarim, S.A. An Overview of Spatial Stimulus-Response (S-R) Compatibility Studies for Further Human Machine Interface Studies. In *Human Factors and Systems Interaction, Proceedings of the 13th International Conference on Applied Human Factors and Ergonomics (AHFE 2022)*, New York, NY, USA, 24–28 July 2022; Nunes, I.L., Ed.; AHFE International: New York, NY, USA, 2022; Volume 52. [[CrossRef](#)]
20. Yin, R.; Wang, D.; Zhao, S.; Lou, Z.; Shen, G. Wearable Sensors-Enabled Human–Machine Interaction Systems: From Design to Application. *Adv. Funct. Mater.* **2021**, *31*, 2008936. [[CrossRef](#)]
21. Fitts, P.M.; Seeger, C.M. S-R compatibility: Spatial characteristics of stimulus and response codes. *J. Exp. Psychol.* **1953**, *46*, 199–210. [[CrossRef](#)]

22. Chan, K.W.L.; Chan, A.H.S. Spatial stimulus–response compatibility for hand and foot controls with vertical plane visual signals. *Displays* **2011**, *32*, 237–243. [[CrossRef](#)]
23. Masaki, H.; Takasawa, N.; Yamazaki, K. An electrophysiological study of the locus of the interference effect in a stimulus-response compatibility paradigm. *Psychophysiology* **2000**, *37*, 464–472. [[CrossRef](#)]
24. Tsang, S.N.H.; Chan, A.H.S. Tracking and discrete dual task performance with different spatial stimulus–response mappings. *Ergonomics* **2015**, *58*, 368–382. [[CrossRef](#)] [[PubMed](#)]
25. Tsang, S.N.H.; Chan, A.H.S. Tracking and discrete dual task performance for different visual spatial stimulus-response mappings with focal and ambient vision. *Appl. Ergon.* **2018**, *67*, 39–49. [[CrossRef](#)] [[PubMed](#)]
26. Yu, Y.; Zhang, B.; Niu, R.; Li, Y.; Liu, Y. The Relationship between Biological Motion-Based Visual Consciousness and Attention: An Electroencephalograph Study. *Neuroscience* **2019**, *415*, 230–240. [[CrossRef](#)] [[PubMed](#)]
27. Talamonti, W.; Tijerina, L.; Blommer, M.; Swaminathan, R.; Curry, R.; Ellis, R.D. Mirage events & driver haptic steering alerts in a motion-base driving simulator: A method for selecting an optimal HMI. *Appl. Ergon.* **2017**, *65*, 90–104. [[CrossRef](#)] [[PubMed](#)]
28. Reeves, A. The Psychometric Function for Focusing Attention on Pitch. *Information* **2023**, *14*, 279. [[CrossRef](#)]
29. Bugg, J.M.; Smallwood, A. The next trial will be conflicting! Effects of explicit congruency pre-cues on cognitive control. *Psychol. Res.* **2016**, *80*, 16–33. [[CrossRef](#)]
30. Martín-Arévalo, E.; Funes, M.J.; Lupiáñez, J. On the time course of spatial cueing: Dissociating between a set for fast reorienting and a set for cue-target segregation. *Acta Psychol.* **2020**, *203*, 103004. [[CrossRef](#)]
31. Allen, P.A.; Smith, A.F.; Vires-Collins, H.; Sperry, S. The psychological refractory period: Evidence for age differences in attentional time-sharing. *Psychol. Aging* **1998**, *13*, 218–229. [[CrossRef](#)]
32. Pütz, S.; Mertens, A.; Chuang, L.; Nitsch, V. Physiological measures of operators’ mental state in supervisory process control tasks: A scoping review. *Ergonomics* **2023**, *67*, 801–830. [[CrossRef](#)]
33. Critchley, H.D.; Garfinkel, S.N. The influence of physiological signals on cognition. *Curr. Opin. Behav. Sci.* **2018**, *19*, 13–18. [[CrossRef](#)]
34. Gegenfurtner, K.R. The Interaction Between Vision and Eye Movements. *Perception* **2016**, *45*, 1333–1357. [[CrossRef](#)] [[PubMed](#)]
35. Krauzlis, R.J.; Goffart, L.; Hafeed, Z.M. Neuronal control of fixation and fixational eye movements. *Philos. Trans. R. Soc. B Biol. Sci.* **2017**, *372*, 20160205. [[CrossRef](#)] [[PubMed](#)]
36. Kang, H. Sample size determination and power analysis using the G\*Power software. *J. Educ. Eval. Health Prof.* **2021**, *18*, 17. [[CrossRef](#)] [[PubMed](#)]
37. Rezae, M.; Chen, N.; McMeekin, D.; Tan, T.; Krishna, A.; Lee, H. The evaluation of a mobile user interface for people on the autism spectrum: An eye movement study. *Int. J. Hum. Comput. Stud.* **2020**, *142*, 102462. [[CrossRef](#)]
38. Nenna, F.; Zanardi, D.; Gamberini, L. Enhanced Interactivity in VR-based Telerobotics: An Eye-tracking Investigation of Human Performance and Workload. *Int. J. Hum. Comput. Stud.* **2023**, *177*, 103079. [[CrossRef](#)]
39. Pires, R.A.; Neves, A.G.M. Asymptotic behavior of mean fixation times in the Moran process with frequency-independent fitnesses. *J. Math. Biol.* **2024**, *88*, 12. [[CrossRef](#)]
40. Fletcher, K.; Neal, A.; Yeo, G. The effect of motor task precision on pupil diameter. *Appl. Ergon.* **2017**, *65*, 309–315. [[CrossRef](#)]
41. Rodriguez, J.D.; Lane, K.J.; Ousler, G.W.; Angjeli, E.; Smith, L.M.; Abelson, M.B. Blink: Characteristics, Controls, and Relation to Dry Eyes. *Curr. Eye Res.* **2018**, *43*, 52–66. [[CrossRef](#)]
42. Palinko, O.; Kun, A.L. Exploring the effects of visual cognitive load and illumination on pupil diameter in driving simulators. In *Proceedings of the Symposium on Eye Tracking Research and Applications*; ACM: New York, NY, USA, 2012; pp. 413–416.
43. Knappen, T.; de Gee, J.W.; Brascamp, J.; Nuiten, S.; Hoppenbrouwers, S.; Theeuwes, J. Cognitive and Ocular Factors Jointly Determine Pupil Responses under Equiluminance. *PLoS ONE* **2016**, *11*, e0155574. [[CrossRef](#)]
44. Mathôt, S.; Van der Stigchel, S. New Light on the Mind’s Eye. *Curr. Dir. Psychol. Sci.* **2015**, *24*, 374–378. [[CrossRef](#)]
45. Franssen, L.; Taberner, J.; Coppens, J.E.; van den Berg, T.J.T.P. Pupil Size and Retinal Straylight in the Normal Eye. *Investig. Ophthalmology Vis. Sci.* **2007**, *48*, 2375. [[CrossRef](#)] [[PubMed](#)]
46. Ebitz, R.B.; Moore, T. Both a Gauge and a Filter: Cognitive Modulations of Pupil Size. *Front. Neurol.* **2019**, *9*, 1190. [[CrossRef](#)]
47. Brych, M.; Händel, B. Disentangling top-down and bottom-up influences on blinks in the visual and auditory domain. *Int. J. Psychophysiol.* **2020**, *158*, 400–410. [[CrossRef](#)] [[PubMed](#)]
48. Callara, A.L.; Greco, A.; Scilingo, E.P.; Bonfiglio, L. Neuronal correlates of eyeblinks are an expression of primary consciousness phenomena. *Sci. Rep.* **2023**, *13*, 12617. [[CrossRef](#)] [[PubMed](#)]
49. Maaß, S.C.; Riemer, M.; Wolbers, T.; van Rijn, H. Timing deficiencies in amnesic Mild Cognitive Impairment: Disentangling clock and memory processes. *Behav. Brain Res.* **2019**, *373*, 112110. [[CrossRef](#)]
50. Radvansky, G.A.; Doolen, A.C.; Pettijohn, K.A.; Ritchey, M. A new look at memory retention and forgetting. *J. Exp. Psychol. Learn. Mem. Cogn.* **2022**, *48*, 1698–1723. [[CrossRef](#)]
51. Li, Y.; Huang, Y.; Li, X.; Ma, J.; Zhang, J.; Li, J. The influence of brightness combinations and background colour on legibility and subjective preference under negative polarity. *Ergonomics* **2022**, *65*, 1046–1056. [[CrossRef](#)]



52. Tonn, S.; van Duijn, A.; Schaaf, M.; Kunde, W. Gaze-Controlled Instructions for Manual Assembly Tasks—A Usability Evaluation Study. In *Proceedings of the Mensch und Computer 2022*; ACM: New York, NY, USA, 2022; pp. 343–348.
53. Zhou, Y.; Li, N.; Zhang, B.; Zhou, T.; Yin, K.; Shi, J. Study on the Interactive Mode of Eye Control Mode in Human–Computer Interface. In *Human Systems Engineering and Design II: Proceedings of the 2nd International Conference on Human Systems Engineering and Design (IHSED2019): Future Trends and Applications, 16–18 September 2019, Universität der Bundeswehr München, Munich, Germany*; Springer: Cham, Switzerland, 2020; pp. 1090–1094.

**Disclaimer/Publisher’s Note:** The statements, opinions and data contained in all publications are solely those of the individual author(s) and contributor(s) and not of MDPI and/or the editor(s). MDPI and/or the editor(s) disclaim responsibility for any injury to people or property resulting from any ideas, methods, instructions or products referred to in the content.